



KD-X560BT

DIGITAL MEDIA RECEIVER

INSTRUCTION MANUAL

JVC KENWOOD Corporation

- Updated information (the latest Instruction Manual, etc.) is available from <http://www.jvc.net/cs/car/>.



Contents

Before use	2
How to read this manual	2
Precautions	2
Getting Started	3
Initial settings	3
Clock settings	3
Basics	4
Common operations	4
How to attach/detach the faceplate	4
Select a source	4
USB	5
Preparation	5
Playback operations	5
Function settings	6
iPod/iPhone	7
Preparation	7
Playback operations	7
Function settings	7
Tuner	8
Tuner basic operations	8
Tuner function settings	8
External Components	9
Using external audio players	9
Rear view camera	9
Bluetooth® smartphone	10
Register your smartphone to the unit	10
Receive a call	10
Make a phone call	11
Playing Bluetooth Audio Device	11
Function settings	12
Setup	12
Settings	12
Sound settings	13
Remote control	14
Functions of the remote control buttons	14
Installation	15
Before installation	15
Installing the unit	16
About this Unit	20
Maintenance	20
More information	20
Troubleshooting	20
Specifications	22
Copyrights	24

Before use

Precautions

▲WARNING

■ To prevent injury or fire, take the following precautions:

- To prevent a short circuit, never put or leave any metallic objects (such as coins or metal tools) inside the unit.
- Do not watch or fix your eyes on the unit's display when you are driving for any extended period.
- If you experience problems during installation, consult your JVC dealer.

■ Precautions on using this unit

- When you purchase optional accessories, check with your JVC dealer to make sure that they work with your model and in your area.
- The Radio Data System or Radio Broadcast Data System feature won't work where the service is not supported by any broadcasting station.

■ Protecting the monitor

- To protect the monitor from damage, do not operate the monitor using a ballpoint pen or similar tool with the sharp tip.

■ How to reset your unit

If the unit or the connected unit fails to operate properly, reset the unit.

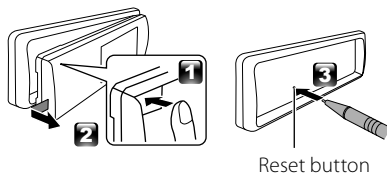

How to read this manual

- The panels shown in this guide are examples used to provide clear explanations of the operations. For this reason, they may be different from the actual panels.
- In operation procedures, bracket shape indicates the item you should control.
[]: indicates the selected items or menu.
< >: indicates the name of panel buttons.
- **Display language:** English is used for the purpose of explanation. You can select a display language from the [Language] menu. See **Language (P.12)**.

Getting Started

Initial settings

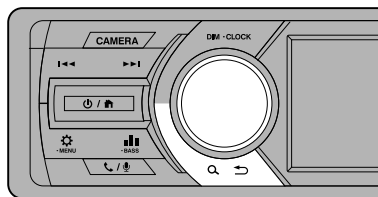

- 1 Turn the ignition key of your car to ACC.
The unit is turned on.
- 2 Turn the volume knob to select the item to set (see the table below), then press the knob to make a selection.

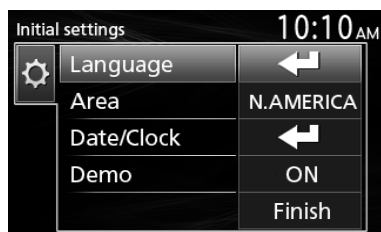

Language

Select the language used for the control screen and setting items. Default is "English".

Area

N.AMERICA (Default): For North America, AM/FM intervals: 10 kHz/200 kHz

S.AMERICA: For Central/South America, AM/FM intervals: 10 kHz/50 kHz

EUROPE: For Europe, AM/FM intervals: 9 kHz/50 kHz.

Date/Clock

Adjust the date, then adjust the time.

Hour / Minute / Month / Day / Year

Demo

Set the demonstration mode. Default is "ON".

- 3 Turn the volume knob to select [Finish], then press the knob.

Clock settings

■ Synchronizing the clock time with FM RDS

Activate [RDS Clock Sync].

See "Tuner function settings" (P.8).

■ Adjusting the clock manually

📎 NOTE

- Deactivate [RDS Clock Sync] before adjusting the clock. See "Tuner function settings" (P.8).

- 1 Press and hold <⚙> to display the settings.
- 2 Press <◀◀>/<▶▶> to select [⚙].
- 3 Turn the volume knob to select [Time Format], then press the knob to select the time format ([12h] or [24h]).

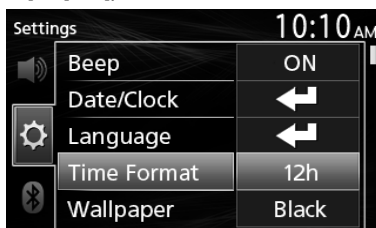

- 4 Turn the volume knob to select [Date/Clock], then press the knob.

Clock screen appears.

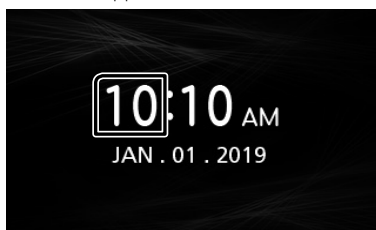

- 5 Turn the volume knob to adjust the hour, then press the knob.
- 6 Turn the volume knob to adjust the minute, then press the knob.
- 7 Turn the volume knob to adjust the month, then press the knob.
- 8 Turn the volume knob to adjust the day, then press the knob.
- 9 Turn the volume knob to adjust the year, then press the knob.
- 10 Press <Q >.

Basics

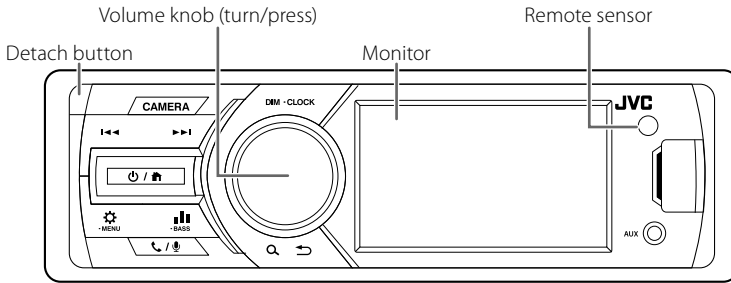

Common operations

Turning on the power

- 1 Press <Power / Home>.

Turning off the power

- 1 Press and hold <Power / Home>.

Adjusting the volume

- 1 Turn the volume knob.

Mutes the sound

- 1 Press and hold the volume knob.
 - appears when the mute function is active.
 - To restore the sound, press and hold again, or adjust the volume.

Display the clock

- 1 Press and hold the <DIM> button.

Select dimmer mode

- 1 Press the <DIM> button.
Dimmer 1, Dimmer 2, Dimmer 3

How to attach/detach the faceplate

Detach

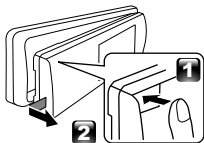

Attach

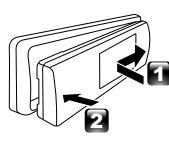

Select a source

- 1 Press <Power / Home> to display the HOME screen. HOME screen appears.
- 2 Turn the volume knob to select the source, then press the knob.

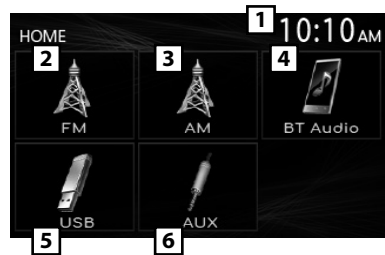

- 1 Clock display
- 2 Switches to the FM tuner broadcast. **(P.8)**
- 3 Switches to the AM tuner broadcast. **(P.8)**
- 4 Plays a Bluetooth audio player. **(P.11)**
- 5 **[USB]** Plays files on a USB device. **(P.5)**
- 6 **[iPod]** Plays an iPod/iPhone. **(P.7)**
 - When iPod/iPhone is connected.
- 6 Switches to an external component connected to the AUX input terminal. **(P.9)**

USB

Preparation

■ Connecting a USB device

- 1 Open the front port cover.
- 2 Connect the USB device with the USB cable (sold separately).

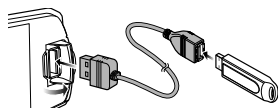

The unit reads the device and playback starts.

- USB maximum power supply current :
DC 5 V = 1 A

■ To disconnect the USB device:

- 1 Press **<⏻ / 🏠>** to display the HOME screen.
- 2 Turn the volume knob to select other than [USB], then press the knob.
- 3 Detach the USB device.

■ Usable USB device

This unit can play MP3/ WMA/ AAC/ WAV/ FLAC/ OGG/ MPEG1/ MPEG2/ MPEG4/ H.264/ MKV/ JPEG/ BMP/ PNG files stored in a USB mass storage class device. **(P.20)**

- File system: FAT16/FAT32/NTFS
- This unit can recognize a total of 20 000 files (Audio files).
- The maximum number of folder layers : 6
- The maximum number of characters:
 - Folder names : 128 characters
 - File names : 128 characters
 - Tag : 128 characters

📎 NOTE

- When the USB device is connected to this unit, it can be charged through the USB cable.
- Install the USB device in the place where it will not affect safe driving.
- You cannot connect a USB device via a USB hub and Multi Card Reader.
- Take backups of the audio files used with this unit. The files may be erased depending on the operating conditions of the USB device. We shall have no compensation for any damage arising from any erased data.
- No USB device comes with this unit. You need to purchase a commercially available USB device.
- Cap the USB terminal whenever not using.

Playback operations

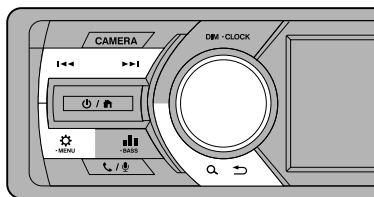

Audio files/Video files

To	Do this
Play/pause	Press the volume knob.
Select a file	Press < ◀◀>/<▶▶ > repeatedly.
Fast-backward/ Fast-forward	Press and hold < ◀◀>/<▶▶ > . <ul style="list-style-type: none">• Video files: Each time you press the button, the search speed changes.

Picture files

To	Do this
Rotates the image	Turn the volume knob.
Zoom	Press the volume knob. <ul style="list-style-type: none">• x2, x3, x4, x1/2, x1/3, x1/4, x1• Turn the volume knob to move the position up and down.• Press < ◀◀>/<▶▶ > to move the position left and right.

■ Source screen (Audio files)

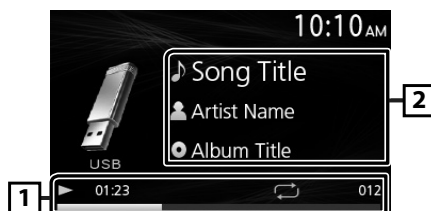

- 1 Playback status/Playing time/File number
Play time bar : For confirmation of current playing position
↺ : Repeat playback mode indicator
⌘ : Random playback mode indicator
- 2 Displays the information of the current file.
Only a file name is displayed if there is no tag information.

USB

■ Selecting a track in a list (Searches file)

- 1 Press <Q> <↵> to display the LIST screen.
- 2 Press <◀◀>/<▶▶> to select whether you search by audio files [🎵], video files [📺] or picture files [🖼️].



- 3 Turn the volume knob to select the desired folder, then press the knob.
 - When you select a folder its contents are displayed.
 - To return to the previous layer, press <Q> <↵>.
- 4 Turn the volume knob to select the desired item, then press the knob.

Playback starts.

Function settings

- 1 Press <⚙️> to display the function menu.
- 2 Turn the volume knob to select the item to set (see the table below), then press the knob to make a selection.
- 3 Press <Q> <↵> to exit.

Audio files (MP3/WMA/AAC)

Repeat	All: Repeats all files. (🔄 indicator lights up.)
	One: Repeats current file. (🔄 indicator lights up.)

Random	OFF: Normal playback.
	ON: Randomly plays all files. (🎲 indicator lights up.)

Video files (MPEG1/ MPEG2/ MPEG4)

Screen Adjustment	Auto/Full/16:9/4:3 : Selects the aspect ratio.
-------------------	--

Repeat	All: Repeats all files.
	One: Repeats current file.

Video Setting	Brightness/Contrast/Color/Tint (0 to 8 : Default 4) : You can adjust image quality.
	Reset: To clear the adjustment.

Picture files (JPEG/ BMP)

Slideshow	ON/OFF: Select the slideshow.
-----------	-------------------------------

Video Setting	Brightness/Contrast/Color/Tint (0 to 8 : Default 4) : You can adjust image quality.
	Reset: To clear the adjustment.

iPod/iPhone

Preparation

■ Connecting iPod/iPhone

- 1 Open the front port cover.
- 2 Connect the iPod/iPhone using the KS-U62 (optional accessory).

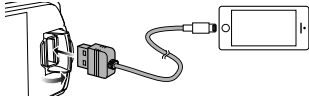

The unit reads the device and playback starts.

- USB maximum power supply current : DC 5 V = 1 A

■ To disconnect the iPod/iPhone

- 1 Press **<⏻ / ⏮>** to display the HOME screen.
- 2 Turn the volume knob to select other than [iPod], then press the knob.
- 3 Detach the iPod/iPhone.

■ Connectable iPod/iPhone

The following models can be connected to this unit.

Made for

- iPhone X
- iPhone SE
- iPhone 5s
- iPhone 8 Plus
- iPhone 6s Plus
- iPod touch (6th generation)
- iPhone 8
- iPhone 6s
- iPhone 7 Plus
- iPhone 6 Plus
- iPhone 7
- iPhone 6

🔧 NOTE

- If you start playback after connecting the iPod, the music that has been played by the iPod is played first.

Playback operations

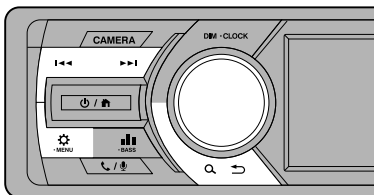

To	Do this
Play/pause	Press the volume knob.
Select a file	Press < ◀◀>>/>>▶▶ > repeatedly.
Fast-backward/ Fast-forward	Press and hold < ◀◀>>/>>▶▶ > .

■ Source screen



- 1 Playback status/Playing time/File number
Play time bar : For confirmation of current playing position
 : Repeat playback mode indicator
 : Random playback mode indicator
- 2 Displays the information of the current file.

■ Selecting a content in a list

- 1 Press **<Q ⏪>** to display the LIST screen.
- 2 Turn the volume knob to select category, then press the knob.
 • To return to the previous layer, press **<Q ⏩>**.
- 3 Turn the volume knob to select the desired item, then press the knob.

Function settings

- 1 Press **<⚙>** to display the function menu.
- 2 Turn the volume knob to select the item to set (see the table below), then press the knob to make a selection.
- 3 Press **<Q ⏪>**.

Repeat	All: Repeats all files. indicator lights up.)
	One: Repeats current file. indicator lights up.)
	OFF: Repeat off.
Random	OFF: Normal playback.
	All: Functions the same as "Shuffle Songs". (indicator lights up.)

Tuner

Tuner basic operations

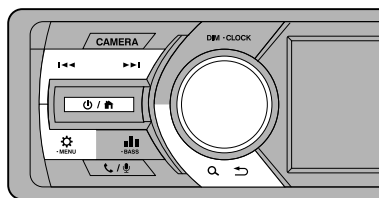

- 1 Press **<⏻ / 🏠>** to display the HOME screen.
- 2 Turn the volume knob to select **[FM]** or **[AM]**, then press the knob.
- 3 Press **<◀◀>/<▶▶>** to search for a station automatically.
"Auto Seek" appears.
(or)
Press and hold **<◀◀>/<▶▶>** repeatedly to search for a station manually.
"Manual Seek" appears.

NOTE

- The **ST** indicator lights up when receiving an FM stereo broadcast with sufficient signal strength.
- To store stations, perform **[Manual Store]** or **[Auto Store]**.

Source screen

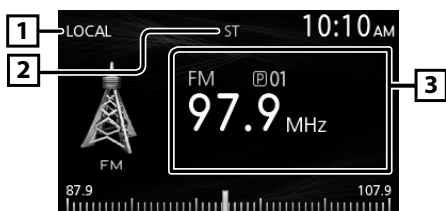

- 1 LOCAL indicator
- 2 ST (Stereo) indicator
- 3 Displays the information of the current station: PS name, Frequency, PTY Genre, Indicator Items

Select a stored station

You can preset 15 stations for FM and 15 stations for AM.

- 1 Press **<🔍 ↶>** to display the LIST screen.
- 2 Turn the volume knob to select a preset number, then press the knob.

NOTE

- To exit, press **<🔍 ↶>**.

Tuner function settings

- 1 Press **<⚙>** to display the function menu.
- 2 Turn the volume knob to select the item to set (see the table below), then press the knob to make a selection.
- 3 Press **<🔍 ↶>**.

Manual Store	Stores a station manually. While listening to a station you want to store, turn the volume knob to select a preset number, then press the knob.
Auto Store	Automatically searches and stores the 15 stations with the strongest signals for the selected band. • "Auto Store" appears.
Local Seek	Tunes in only to the stations with sufficient signal strength. (LOCAL indicator lights up.) "ON", "OFF" (Default)
Area	N.AMERICA (Default): For North America, AM/FM intervals: 10 kHz/200 kHz S.AMERICA: For Central/South America, AM/FM intervals: 10 kHz/50 kHz EUROPE: For Europe, AM/FM intervals: 9 kHz/50 kHz.
Mono *1	Determines whether to receive stereo broadcasts in the stereo mode or monaural mode (the MONO indicator lights up). "ON", "OFF" (Default)
RDS Clock Sync *1	Synchronizing the Radio Data System station time data and this unit's clock. "ON" (Default), "OFF"

*1 FM only

External Components

Using external audio players

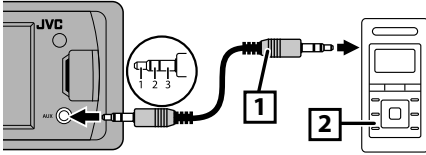

- 1 3.5 mm stereo mini plug (Sold separately)
Use a 3-core plug head stereo mini plug for optimum audio output.
- 2 Portable audio player (Sold separately)

Starting playback

- 1 Connect an external component to the AUX input terminal.
- 2 Press **<⏻ / 🏠>** to display the HOME screen.
- 3 Turn the volume knob to select [AUX], then press the knob.
- 4 Turn on the connected component and start playing the source.

Rear view camera

To use a rear view camera, the REVERSE lead connection is required. For connecting a rear view camera. (P.18)

Displaying the picture from the rear view camera

The rear view screen is displayed when you shift the gear to the reverse (R) position.



To display the picture from the rear view camera manually

- 1 Press **<CAMERA>**.

Bluetooth® smartphone

■ About the Bluetooth smartphone and Bluetooth audio player

This unit conforms to the following Bluetooth specifications:

Version

Bluetooth Ver.4.2

Profile

Smartphone/ Cell-phone:

HFP (Hands Free Profile)

PBAP (Phonebook Access Profile)

Audio player:

A2DP (Advanced Audio Distribution Profile)

AVRCP (Audio/Video Remote Control Profile)

Sound codec

SBC

■ About smartphone compatible with Phone book Access Profile (PBAP)

If your smartphone supports PBAP, you can display the following items when the smartphone is connected.

- Phone book (up to 1000 entries)
- Dialed calls, received calls, and missed calls (up to 20 entries in total)

Register your smartphone to the unit

You can use your Bluetooth smartphone when paired to this unit.

- You can pair the device and the unit using SSP (Secure Simple Pairing) which only requires confirmation.
- One device can be connected at a time.
- When you register a new Bluetooth device, disconnect the Bluetooth device currently connected and then register the new device.

1 Turn on the Bluetooth function on your smartphone/cell-phone.

2 Search the unit ("KD-X56*") from your smartphone/cell-phone.

If a PIN code is required, enter the PIN code ("0000").

■ Disconnecting the device

- Turn off the Bluetooth function from your smartphone/cell-phone.
- Turn off the ignition switch.

Receive a call

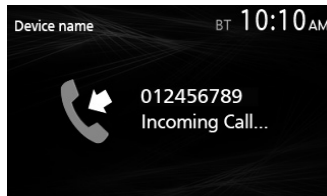
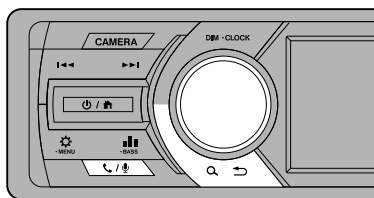

To	Do this
Answer a call	Press <CALL> / <MICROPHONE>.

■ Operations during a call

To	Do this
End a call	Press <CALL> / <MICROPHONE>.

Adjust the phone volume	Turn the volume knob.
-------------------------	-----------------------

Switching between hands-free mode and phone mode	Press <CALL> <MICROPHONE>. Each time you press the button, "Transfer!" appears and talking method is switched between hands-free mode and phone mode.
--	---

Bluetooth® smartphone

Make a phone call

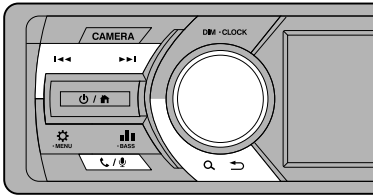

1 Press <Call icon / Mic icon> to enter Bluetooth mode.



2 Press <Left arrow / Right arrow> to select a method to make a call ([Call icon]: from the calls history/[Phone icon]: from the phone book).

3 Turn the volume knob to select the target, then press the knob to make a call.

NOTE

- Calls history icon: [Phone icon] (Incoming Calls), [Call icon] (Outgoing Calls), [Missed icon] (Missed Calls).

Call by voice

1 Press and hold <Call icon / Mic icon> to display the voice dialing screen.

You can also display the voice dialing screen by selecting [Phone icon] as the method to make a call on the phone screen.

2 Press the volume knob to activate voice recognition function.

“Please speak after the beep” appears and the beep sounds.

3 Say the name of the person you want to call.

Playing Bluetooth Audio Device

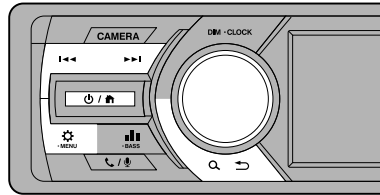

1 Press <Power / Home icon> to display the HOME screen.

2 Turn the volume knob to select [BT Audio], then press the knob.

To	Do this
Play/pause	Press the volume knob.
Select a file	Press <Left arrow / Right arrow> repeatedly.
Fast-backward/ Fast-forward	Press and hold <Left arrow / Right arrow>.

Source screen

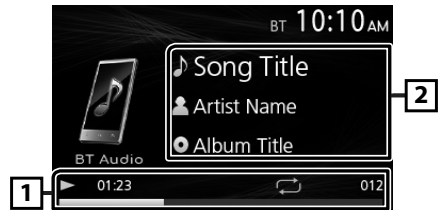

1 Playback status/Playing time/File number

Play time bar : For confirmation of current playing position

[Repeat icon] : Repeat playback mode indicator

[Random icon] : Random playback mode indicator

2 Displays the information of the current file.

NOTE

- Operations and display indications may differ according to their availability on the connected device.

Selecting a content in a list

1 Press <Search icon / Back icon> to display the LIST screen.

2 Turn the volume knob to select an item, then press the knob.

- To return to the previous layer, press <Search icon / Back icon>.

Bluetooth smartphone

Setup

Function settings

- 1 Press to display the function menu.
- 2 Turn the volume knob to select the item to set (see the table below), then press the knob to make a selection.
- 3 Press to exit.

Repeat	All: Repeats all files. indicator lights up.)
	One: Repeats current file. indicator lights up.)
	OFF: Repeat off.

Random	OFF: Normal playback.
	All: Randomly plays all files. indicator lights up.)

Settings

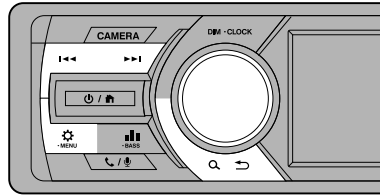

- 1 Press and hold to display the settings.

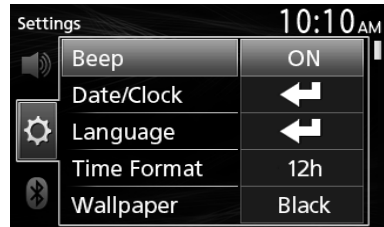

- 2 Press to select the category.
- 3 Turn the volume knob to select an item (see the following table), then press the knob.
- 4 Repeat step 3 until the desired item is selected/activated or follow the instructions stated on the selected item.
- 5 Press .

Audio Settings

Fader	R12 — F12 (00): Adjusts the front and rear speaker output balance.
Balance	L12 — R12 (00): Adjusts the left and right speaker output balance.

General Settings

Beep	ON/OFF: Activates or deactivates the keypress tone. Default is "ON".
Date/Clock	Adjusts the date and clock. (P.3)
Language	Selects the text language used for on-screen information.
Time Format	12h/24h: Selects time format. Default is "12h".
Wallpaper	Black/Blue: Selects the wallpaper image.
Demo	Set the demonstration mode. Default is "ON".
Initialize	Select [Initialize] and then select [Yes] to set all the settings to the initial default settings.

Setup

Bluetooth Settings

Sync	ON/OFF: Activates or deactivates the synchronization of the phonebook in the connected smartphone with the unit.
Phonebook	
BT Information	Displays the information about the connected Bluetooth device (device name, phone name, and mac address).

Sound settings

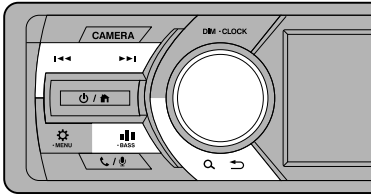

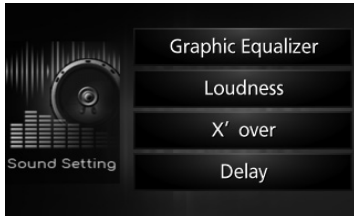

1 Press  to display the sound setting.



2 Turn the volume knob to select an item (see the following table), then press the knob.



3 Repeat step 2 until the desired item is selected/activated or follow the instructions stated on the selected item.

4 Press .



Graphic Equalizer	Selects a preset equalizer suitable to the music genre. Flat / DRVN / Hard Rock / Hip Hop / Jazz / Pop / R & B / User / Classical Select [User] to use the settings made 1) Press the volume knob to select the frequency. 2) Turn the volume knob to adjust the level. 3) Press  .
--------------------------	---

Loudness	Sets the amounts of boost of low and high tones. "ON", "OFF" (Default)
-----------------	---

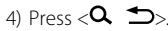
X'over You can set the crossover frequency of speakers.

- 1) Press / to select the speaker.
- 2) Press the volume knob to select the item.
- 3) Turn the volume knob to adjust the value.
- 4) Press .

Delay Adjust the sound delay time so that the sounds from different speakers arrive at the listener sitting on the selected seat at the same time.

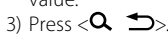
- 1) Press / to select the speaker.
- 2) Turn the volume knob to adjust the value.
- 3) Press .

Remote control

This unit can be operated using the remote control. The remote control RM-RK258 (optional accessory) can be used.

Functions of the remote control buttons

- Aim the remote control directly at the remote sensor on the faceplate.
- DO NOT expose the remote sensor to bright light (direct sunlight or artificial lighting).

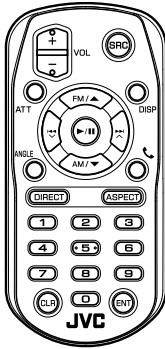

SRC	Switches to the source to be played.
VOL + -	Adjusts the volume.
ATT	Mutes/restores the sound
DISP	Select dimmer mode.
FM/▲	Selects the folder to be played.
AM/▼	
◀▶	Selects the track or file to be played.
▶▶	During tuner source, switches to broadcast stations received by the unit.
ANGLE	Not used.
☎	When a call comes in, answers the call.
DIRECT	Not used.
ASPECT	Not used.
Numeric Keypad	Not used.
CLR	Not used.
ENT	Not used.

Installation

Before installation

Before installation of this unit, please note the following precautions.

▲WARNINGS

- If you connect the ignition wire (red) and the battery wire (yellow) to the car chassis (ground), you may cause a short circuit, that in turn may start a fire. Always connect those wires to the power source running through the fuse box.
- Do not cut out the fuse from the ignition wire (red) and the battery wire (yellow). The power supply must be connected to the wires via the fuse.

▲CAUTION

- Install this unit in the console of your vehicle. Do not touch the metal part of this unit during and shortly after the use of the unit. Metal part such as the heat sink and enclosure become hot.







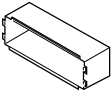

🔧 NOTE

- Mounting and wiring this product requires skills and experience. For best safety, leave the mounting and wiring work to professionals.
- Make sure to ground the unit to a negative 12V DC power supply.
- Do not install the unit in a spot exposed to direct sunlight or excessive heat or humidity. Also avoid places with too much dust or the possibility of water splashing.
- Do not use your own screws. Use only the screws provided. If you use the wrong screws, you could damage the unit.
- If your car's ignition does not have an ACC position, connect the ignition wires to a power source that can be turned on and off with the ignition key. If you connect the ignition wire to a power source with a constant voltage supply, such as with battery wires, the battery may be drained.
- If the console has a lid, make sure to install the unit so that the front panel will not hit the lid when closing and opening.
- If the fuse blows, first make sure the wires aren't touching to cause a short circuit, then replace the old fuse with one with the same rating.
- Insulate unconnected wires with vinyl tape or other similar material. To prevent a short circuit, do not remove the caps on the ends of the unconnected wires or the terminals.
- Secure the wires with cable clamps and wrap vinyl tape around the wires that comes into contact with metal parts to protect the wires and to prevent short circuit.

- Connect the speaker wires correctly to the terminals to which they correspond. The unit may be damaged or fail to work if you share the ⊖ wires or ground them to any metal part in the car.
- When only two speakers are being connected to the system, connect the connectors either to both the front output terminals or to both the rear output terminals (do not mix front and rear). For example, if you connect the ⊕ connector of the left speaker to a front output terminal, do not connect the ⊖ connector to a rear output terminal.
- After the unit is installed, check whether the brake lamps, blinkers, wipers, etc. on the car are working properly.
- Mount the unit so that the mounting angle is 30° or less.
- Do not press hard on the panel surface when installing the unit to the vehicle. Otherwise scars, damage, or failure may result.
- Reception may drop if there are metal objects near the Bluetooth antenna.



■ Supplied accessories for installation

①		x1	②		x1
③		x2	④		x1
⑤ (3 m)		x1	⑥		x1
⑦		x1	⑧	 (M5 × 6 mm)	x6
⑨	 (M5 × 8 mm)	x6			

Installation

Installation procedure

- 1) To prevent a short circuit, remove the key from the ignition and disconnect the \ominus terminal of the battery.
- 2) Make the proper input and output wire connections for each unit.
- 3) Connect the wire on the wiring harness.
- 4) Take Connector B on the wiring harness and connect it to the speaker connector in your vehicle.
- 5) Take Connector A on the wiring harness and connect it to the external power connector on your vehicle.
- 6) Connect the wiring harness connector to the unit.
- 7) Install the unit in your car.
- 8) Reconnect the \ominus terminal of the battery.
- 9) Press the reset button.

Installing the unit

Non-Japanese cars

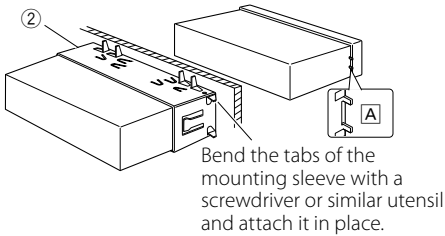

NOTE

- Make sure that the unit is installed securely in place. If the unit is unstable, it may malfunction (eg, the sound may skip).
- If the panel opening of your vehicle is too small to fit the unit (A), trim (the upper and lower sides and right and left sides of) panel opening.

Japanese cars (North America, South America sales area only)

⑧ or ⑨

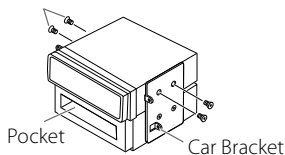

Trim plate

- 1) Attach accessory ① to the unit.

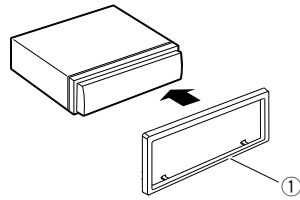

Microphone unit

- 1) Check the installation position of the microphone (accessory ⑤).
- 2) Clean the installation surface.
- 3) Remove the separator of the microphone (accessory ⑤), and stick the microphone to the place shown below.
- 4) Wire the microphone cable up to the unit with it secured at several positions using tape or other desired method.
- 5) Adjust the direction of the microphone (accessory ⑤) to the driver.

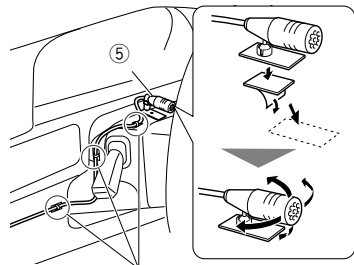

Fix a cable with a commercial item of tape.

NOTE

- Use the clips if necessary.

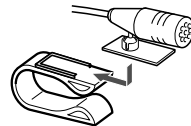

Installation

■ Removing the trim plate

- 1) Use the extraction key (accessory ④) to lever out the four tabs (two on the top part, two on the bottom part).

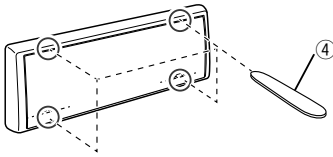

- 2) Pull the trim plate forward.

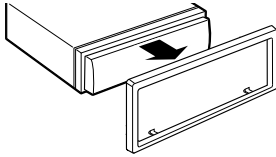

■ Removing the unit

- 1) Remove the trim plate by referring to step 1 in "Removing the trim plate".
- 2) Detach the faceplate.

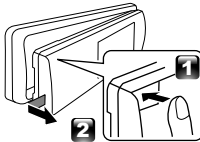

- 3) Insert the two extraction key (accessory ③) deeply into the slots on each side, as shown.

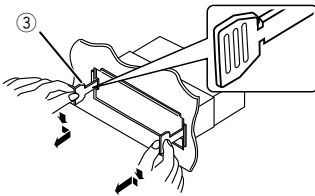

- 4) Lower the removal tool toward the bottom, and pull out the unit halfway while pressing towards the inside.

🔧 NOTE

- Be careful to avoid injury from the catch pins on the extraction key.
- 5) Pull the unit all the way out with your hands, being careful not to drop it.

Installation

■ Connecting wires to terminals

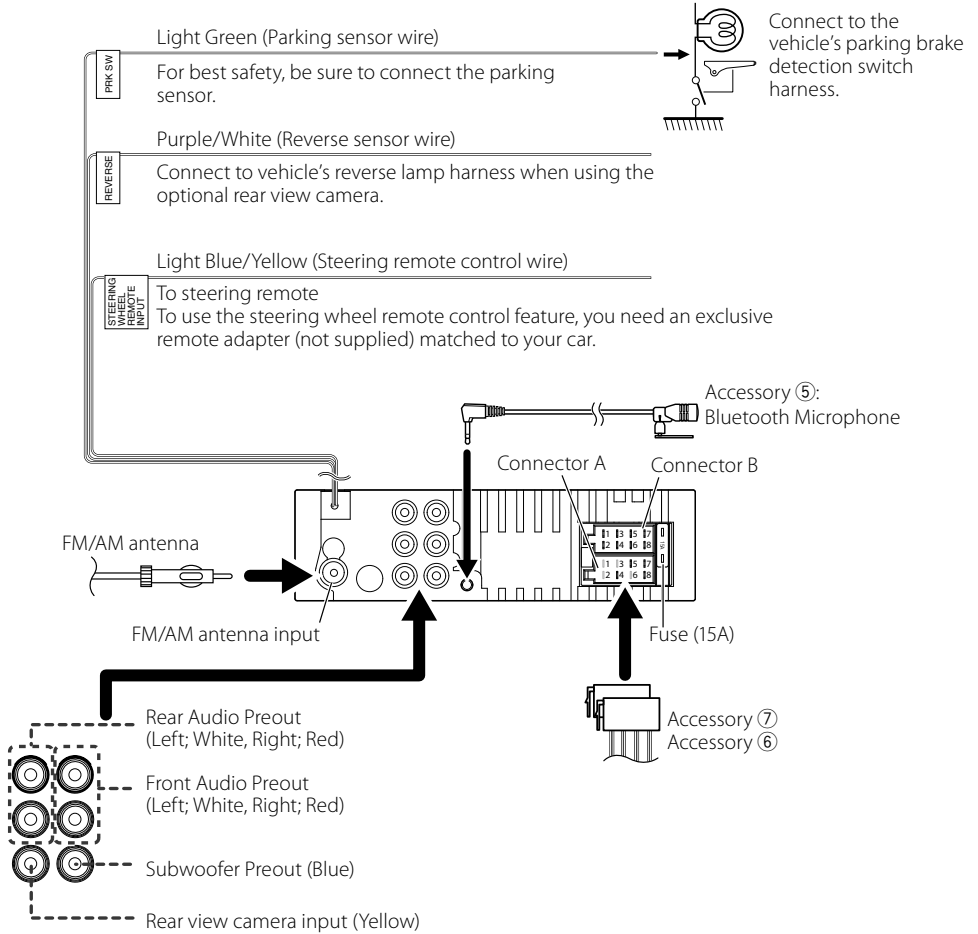

Installation

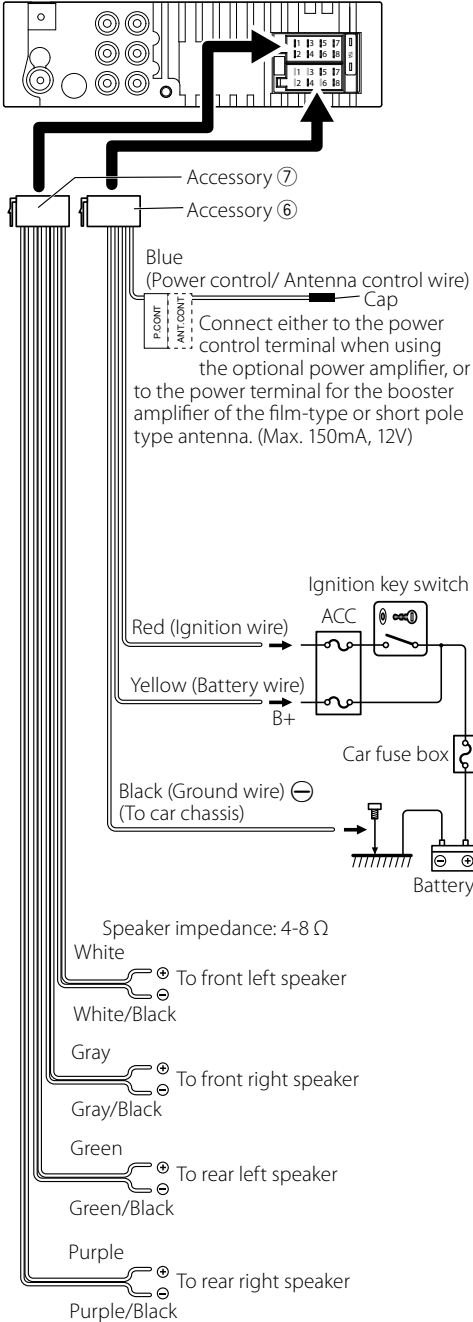

About this Unit

Maintenance

■ Cleaning the Unit

If the front panel of this unit is stained, wipe it with a dry soft cloth such as a silicon cloth. If the front panel is stained badly, wipe the stain off with a cloth moistened with neutral cleaner, then wipe it again with a clean soft dry cloth.

⚠ CAUTION

- Applying spray cleaner directly to the unit may affect its mechanical parts. Wiping the front panel with a hard cloth or using a volatile liquid such as thinner or alcohol may scratch the surface or erase screened print.

■ Cleaning the connector

Detach the faceplate and clean the connector gently with a cotton swab. Be careful not to damage the connector.



Connector (on the reverse side of the faceplate)

More information

■ Playable Audio files

Audio format	Bit rate/ Bit count	Sampling frequency
MP3 (.mp3)	32 – 320kbps, VBR	16 – 48 kHz
WMA (.wma)	16 – 384kbps	8 – 48 kHz
AAC-LC (.m4a)	16 – 448kbps	8 – 48 kHz
WAV (.wav)	16/24 bit	8 – 96 kHz
FLAC (.flac)	16/24 bit	8 – 96 kHz
Vorbis (.ogg)	500kbps	48 kHz

- This unit can show ID3 Tag Version 1.0/1.1/2.2/2.3/2.4 (for MP3).
- The maximum number of characters:
 - Tag : 128 characters

📎 NOTE

- WMA and AAC of which is covered with DRM cannot be played.
- Although the audio files are complied with the standards listed above, the play may be impossible depending on the types or conditions of media or device.

■ Acceptable Video files

Video format	Video codec	Audio codec
MPEG-1 (.mpg, .mpeg)	MPEG-1	MPEG1 Audio Layer 2
MPEG-2 (.mpg, .mpeg)	MPEG-2	MPEG1 Audio Layer 2
MPEG-4 (.mp4, .avi)	MPEG-4	MP3, AAC-LC (2ch)
H.264 (.mp4, .mkv, .avi, .flv, .f4v)	H.264/MPG-4 AVC	MP3, AAC
Matroska (.mkv)	H.264/MPEG-4 AVC, MPEG4	MP3, AAC, LPCM

■ Acceptable Picture files

- JPEG (.jpg)
 - 32 x 32 to 5,000 x 5,000 resolution
 - It may take time to display the file.
- BMP (.bmp)
 - 32 x 32 to 5,000 x 5,000 resolution
 - It may take time to display the file.
- PNG (.png)
 - 32 x 32 to 5,000 x 5,000 resolution
 - It may take time to display the file.

About this Unit

Troubleshooting

What appears to be trouble is not always serious. Check the following points before calling a service center.

- For operations with the external components, refer also to the instructions supplied with the adapters used for the connections (as well as the instructions supplied with the external components).

■ General

No sound comes out of the speakers.

- Adjust the volume to the optimum level.
- Check the cords and connections.

The unit does not work at all.

- Reset the unit. (P.2)

The remote controller does not work.

- Replace the battery.

■ USB

While playing a track, sound is sometimes interrupted.

- The tracks are not properly copied into the USB device. Copy the tracks again, and try again.

■ iPod/iPhone

No sound comes out of the speakers.

- Disconnect the iPod/iPhone, then connect it again.
- Select another source, then reselect "iPod".

The iPod/iPhone does not turn on or does not work.

- Check the connecting cable and its connection.
- Update the firmware version of iPod/iPhone.
- Charge the battery of iPod/iPhone.
- Reset the iPod/iPhone.

Sound is distorted.

- Deactivate the equalizer either on this unit or the iPod/iPhone.

A lot of noise is generated.

- Turn off (uncheck) "VoiceOver" on the iPod/iPhone. For details, visit <<http://www.apple.com>>.

■ Tuner

Automatic presetting does not work.

- Store stations manually. (P.8)

Static noise while listening to the radio.

- Connect the antenna firmly.

■ Bluetooth

Phone sound quality is poor.

- Reduce the distance between the unit and the Bluetooth mobile phone.
- Move the car to a place where you can get a better signal reception.

The sound is interrupted or skipped while using a Bluetooth audio player.

- Reduce the distance between the unit and the Bluetooth audio player.
- Turn off, then turn on the unit. (When the sound is not yet restored) connect the player again.

The connected audio player cannot be controlled.

- Check whether the connected audio player supports AVRCP (Audio/Video Remote Control Profile).

The Bluetooth device does not detect the unit.

- Search from the Bluetooth device again.

The unit does not pair with the Bluetooth device.

- Turn off, then turn on the Bluetooth device.
- Disconnect the Bluetooth device currently connected and then register the new device. (P.10)

About this Unit

Specifications

■ Monitor section

- Picture Size
: 3.0 inch display
- Drive System
: TFT active matrix system
- Number of Pixels
: 320H x 240V
- Aspect Ratio
: 16:9(wide)
- Back Lighting
: LED

■ USB interface section

- USB Standard
: USB 2.0 High Speed
- File System
: FAT 16/ 32, NTFS
- Maximum Power Supply Current
: DC 5 V  1.0 A

- Frequency Response
: 20 – 20,000 Hz

- Audio Decoder
: MP3/ WMA/ AAC/ WAV/ FLAC/ OGG

- Video Decoder
: MPEG1/ MPEG2/ MPEG4/ H.264/ MKV/ JPEG/ BMP/
PNG

■ Bluetooth section

- Technology
: Bluetooth Ver.4.2
- Frequency
: 2.402 – 2.480 GHz
- Output Power
: +8 dBm (AVE), Power Class1
- Maximum Communication range
: Line of sight approx. 10m (32.8 ft)
- Audio Codec
SBC
- Profile (Multi Profile support)
- HFP (Hands Free Profile)
 - A2DP (Advanced Audio Distribution Profile)
 - AVRCP (Audio/Video Remote Control Profile)
 - PBAP (Phonebook Access Profile)

■ FM tuner section

- Frequency Range (step)
: 87.9 MHz – 107.9 MHz (200 kHz)
- Usable Sensitivity
: 13.2 dBf
- Frequency Response
: 30 Hz – 14 kHz
- S/N Ratio (dB)
: 55 dB (MONO)
- Stereo separation
: 35 dB (1kHz)

■ AM tuner section

- Frequency Range (step)
: 530 – 1700 kHz (10 kHz)
- Usable Sensitivity
: 35 dB μ

■ DSP section

- Graphics equalizer
Band :13 Band
Frequency: 62.5/100/160/250/400/630/1k/1.6k/2.5k/
4k/6.3k/10k/16kHz
Gain: -9 – +9 dB (1 dB/Step)
- 2Way X'Over
High pass filter
Frequency: Through, 40/60/80/120/160 Hz
Slope: -6/-12/-18/-24 dB/Oct.
Gain: -8/-7/-6/-5/-4/-3/-2/-1/0 dB
- Low pass filter
Frequency: Through, 40/60/80/120/160 Hz
Slope: -6/-12/-18/-24 dB/Oct.
Gain: -8/-7/-6/-5/-4/-3/-2/-1/0 dB
- Position
Front/Rear/Subwoofer Delay:
0-18 mS (0.03 mS/Step)

■ Video section

- Video Input Level
: 1.0 V_{p-p}/ 75 Ω

■ AUX section

- External Audio Max input Level
: 1.5 V/ 25 k Ω

About this Unit

■ Audio section

Maximum Power (Front & Rear)

: 45 W × 4

Full Bandwidth Power (1% THD)

: 16 W × 4

Preout Impedance

: 10 k Ω

Preout Level/Load

: 2.0 V/10 k Ω

Speaker Impedance

: 4 – 8 Ω

■ General

Operating Voltage

: 12 V DC car battery

Installation Dimensions (W × H × D)

: 182 × 52 × 117 mm (with sleeve)

7-3/16 × 2-1/16 × 4-5/8 inch

Weight

: 0.75 kg (1.65 lbs)

NOTE

- Although the effective pixels for the liquid crystal panel is given as 99.99% or more, 0.01% of pixels may not light or may light incorrectly.
- Specifications subject to change without notice.

About this Unit

Copyrights

- The Bluetooth word mark and logos are registered trademarks owned by the Bluetooth SIG, Inc. and any use of such marks by JVC KENWOOD Corporation is under license. Other trademarks and trade names are those of their respective owners.
- Use of the Made for Apple badge means that an accessory has been designed to connect specifically to the Apple product(s) identified in the badge, and has been certified by the developer to meet Apple performance standards. Apple is not responsible for the operation of this device or its compliance with safety and regulatory standards. Please note that the use of this accessory with an Apple product may affect wireless performance.
- Apple, iPhone, iPod, iPod touch, and Lightning are trademarks of Apple Inc., registered in the U.S. and other countries.
- Microsoft and Windows Media are either registered trademarks or trademarks of Microsoft Corporation in the United States and/or other countries.
- THIS PRODUCT IS LICENSED UNDER THE MPEG-4 VISUAL PATENT PORTFOLIO LICENSE FOR THE PERSONAL AND NON-COMMERCIAL USE OF A CONSUMER FOR (i) ENCODING VIDEO IN COMPLIANCE WITH THE MPEG-4 VISUAL STANDARD ("MPEG-4 VIDEO") AND/OR (ii) DECODING MPEG-4 VIDEO THAT WAS ENCODED BY A CONSUMER ENGAGED IN A PERSONAL AND NON-COMMERCIAL ACTIVITY AND/OR WAS OBTAINED FROM A VIDEO PROVIDER LICENSED BY MPEG LA TO PROVIDE MPEG-4 VIDEO. NO LICENSE IS GRANTED OR SHALL BE IMPLIED FOR ANY OTHER USE. ADDITIONAL INFORMATION INCLUDING THAT RELATING TO PROMOTIONAL, INTERNAL AND COMMERCIAL USES AND LICENSING MAY BE OBTAINED FROM MPEG LA, LLC. SEE [HTTP://WWW.MPEGLA.COM](http://www.mpegla.com).
- THIS PRODUCT IS LICENSED UNDER THE AVC PATENT PORTFOLIO LICENSE FOR THE PERSONAL USE OF A CONSUMER OR OTHER USES IN WHICH IT DOES NOT RECEIVE REMUNERATION TO (i) ENCODE VIDEO IN COMPLIANCE WITH THE AVC STANDARD ("AVC VIDEO") AND/OR (ii) DECODE AVC VIDEO THAT WAS ENCODED BY A CONSUMER ENGAGED IN A PERSONAL ACTIVITY AND/OR WAS OBTAINED FROM A VIDEO PROVIDER LICENSED TO PROVIDE AVC VIDEO. NO LICENSE IS GRANTED OR SHALL BE IMPLIED FOR ANY OTHER USE. ADDITIONAL INFORMATION MAY BE OBTAINED FROM MPEG LA, L.L.C. SEE [HTTP://WWW.MPEGLA.COM](http://www.mpegla.com)
- libFLAC
Copyright (C) 2000-2009 Josh Coalson
Copyright (C) 2011-2013 Xiph.Org Foundation
– Redistribution and use in source and binary forms,

- with or without modification, are permitted provided that the following conditions are met:
 - Redistributions of source code must retain the above copyright notice, this list of conditions and the following disclaimer.
 - Redistributions in binary form must reproduce the above copyright notice, this list of conditions and the following disclaimer in the documentation and/or other materials provided with the distribution.

Neither the name of the Xiph.org Foundation nor the names of its contributors may be used to endorse or promote products derived from this software without specific prior written permission. THIS SOFTWARE IS PROVIDED BY THE COPYRIGHT HOLDERS AND CONTRIBUTORS "AS IS" AND ANY EXPRESS OR IMPLIED WARRANTIES, INCLUDING, BUT NOT LIMITED TO, THE IMPLIED WARRANTIES OF MERCHANTABILITY AND FITNESS FOR A PARTICULAR PURPOSE ARE DISCLAIMED. IN NO EVENT SHALL THE FOUNDATION OR CONTRIBUTORS BE LIABLE FOR ANY DIRECT, INDIRECT, INCIDENTAL, SPECIAL, EXEMPLARY, OR CONSEQUENTIAL DAMAGES (INCLUDING, BUT NOT LIMITED TO, PROCUREMENT OF SUBSTITUTE GOODS OR SERVICES; LOSS OF USE, DATA, OR PROFITS; OR BUSINESS INTERRUPTION) HOWEVER CAUSED AND ON ANY THEORY OF LIABILITY, WHETHER IN CONTRACT, STRICT LIABILITY, OR TORT (INCLUDING NEGLIGENCE OR OTHERWISE) ARISING IN ANY WAY OUT OF THE USE OF THIS SOFTWARE, EVEN IF ADVISED OF THE POSSIBILITY OF SUCH DAMAGE.

- libogg
Copyright (c) 2002, Xiph.org Foundation
Redistribution and use in source and binary forms, with or without modification, are permitted provided that the following conditions are met:
 - Redistributions of source code must retain the above copyright notice, this list of conditions and the following disclaimer.
 - Redistributions in binary form must reproduce the above copyright notice, this list of conditions and the following disclaimer in the documentation and/or other materials provided with the distribution.
 - Neither the name of the Xiph.org Foundation nor the names of its contributors may be used to endorse or promote products derived from this software without specific prior written permission. THIS SOFTWARE IS PROVIDED BY THE COPYRIGHT HOLDERS AND CONTRIBUTORS "AS IS" AND ANY EXPRESS OR IMPLIED WARRANTIES, INCLUDING, BUT NOT LIMITED TO, THE IMPLIED WARRANTIES OF MERCHANTABILITY AND FITNESS FOR A PARTICULAR PURPOSE ARE DISCLAIMED. IN NO EVENT SHALL

About this Unit

THE FOUNDATION OR CONTRIBUTORS BE LIABLE FOR ANY DIRECT, INDIRECT, INCIDENTAL, SPECIAL, EXEMPLARY, OR CONSEQUENTIAL DAMAGES (INCLUDING, BUT NOT LIMITED TO, PROCUREMENT OF SUBSTITUTE GOODS OR SERVICES; LOSS OF USE, DATA, OR PROFITS; OR BUSINESS INTERRUPTION) HOWEVER CAUSED AND ON ANY THEORY OF LIABILITY, WHETHER IN CONTRACT, STRICT LIABILITY, OR TORT (INCLUDING NEGLIGENCE OR OTHERWISE) ARISING IN ANY WAY OUT OF THE USE OF THIS SOFTWARE, EVEN IF ADVISED OF THE POSSIBILITY OF SUCH DAMAGE.

About this Unit

For USA

FCC WARNING

This equipment may generate or use radio frequency energy. Changes or modifications to this equipment may cause harmful interference unless the modifications are expressly approved in the instruction manual. The user could lose the authority to operate this equipment if an unauthorized change or modification is made.

NOTE

- This equipment has been tested and found to comply with the limits for a Class B digital device, pursuant to Part 15 of the FCC Rules. These limits are designed to provide reasonable protection against harmful interference in a residential installation.
- This equipment may cause harmful interference to radio communications, if it is not installed and used in accordance with the instructions. However, there is no guarantee that interference will not occur in a particular installation. If this equipment does cause harmful interference to radio or television reception, which can be determined by turning the equipment off and on, the user is encouraged to try to correct the interference by one or more of the following measures:
 - Reorient or relocate the receiving antenna.
 - Increase the separation between the equipment and receiver.
 - Connect the equipment into an outlet on a circuit different from that to which the receiver is connected.
 - Consult the dealer or an experienced radio/TV technician for help.

This transmitter must not be co-located or operated in conjunction with any other antenna or transmitter.

For Canada

IC (Industry Canada) Notice

This device complies with Industry Canada's applicable licence-exempt RSSs.

Operation is subject to the following two conditions:

- (1) This device may not cause interference, and
- (2) this device must accept any interference, including interference that may cause undesired operation of the device.

CAUTION

This equipment complies with FCC/IC radiation exposure limits set forth for an uncontrolled environment and meets the FCC radio frequency (RF) Exposure Guidelines and RSS-102 of the IC radio frequency (RF) Exposure rules. This equipment should be installed and operated keeping the radiator at least 20cm or more away from person's body.

Supplier's Declaration of Conformity

Trade Name: JVC
Products: DIGITAL MEDIA RECEIVER
Model Name: KD-X560BT
Responsible Party: JVCKENWOOD USA CORPORATION
2201 East Dominguez Street,
Long Beach, CA 90810, U.S.A.
PHONE: 310 639-9000

THIS DEVICE COMPLIES WITH PART 15 OF THE FCC RULES. OPERATION IS SUBJECT TO THE FOLLOWING TWO CONDITIONS:

- (1) THIS DEVICE MAY NOT CAUSE HARMFUL INTERFERENCE, AND
- (2) THIS DEVICE MUST ACCEPT ANY INTERFERENCE RECEIVED, INCLUDING INTERFERENCE THAT MAY CAUSE UNDESIRED OPERATION.

- Contains Transmitter Module
- FCC ID: 2AB7S-KD-X560BT
- Contains Transmitter Module
- IC: 11888A-KDX560BT

About this Unit

For Argentina

■ Información acerca de la eliminación de equipos eléctricos y electrónicos al final de la vida útil (aplicable a los países que hayan adoptado sistemas independientes de recogida de residuos)



Los productos con el símbolo de un contenedor con ruedas tachado no podrán ser desechados como residuos domésticos.

Los equipos eléctricos y electrónicos al final de la vida útil, deberán ser reciclados en instalaciones que puedan dar el tratamiento adecuado a estos productos y a sus subproductos residuales correspondientes. Póngase en contacto con su administración local para obtener información sobre el punto de recogida más cercano. Un tratamiento correcto del reciclaje y la eliminación de residuos ayuda a conservar los recursos y evita al mismo tiempo efectos perjudiciales en la salud y el medio ambiente.

For Mexico

■ Para cumplimiento de la IFT:

La operación de este equipo esta sujeta a las siguientes dos condiciones:

- (1) es posible que este equipo o dispositivo no cause interferencia perjudicial y
- (2) este equipo o dispositivo debe aceptar cualquier interferencia, incluyendo la que pueda causar su operación no deseada.

JVC